

SPEL Separator Commissioning Operation and Maintenance

SPEL

Puraceptor Class 1

Operation and Maintenance Manual

Introduction

Congratulations on your purchase of a SPEL Environmental Stormwater Quality Improvements Device.
With proper care and by following a few simple guide lines your system will give you many years of dependable service.

Important

Only qualified personnel should maintain, operate and repair you Stormwater system. Any wiring of equipment should be performed by a qualified electrician.

Warning

Operation may cause injury. Take all necessary precautions, wear protective equipment, refer to Engineers Department.
For your own safety, read all instruction manuals prior to working on equipment.

Safety Precautions

- Follow all “occupation, health and safety” regulations.
- Ensure maintenance personnel are aware of “Confined Spaces” guidelines, which must be followed.
 - Make sure that there is sufficient oxygen and that there are no poisonous gases present.
 - Check the explosion risk before welding or using electric hand tools.
 - Do not ignore health hazards. Observe strict cleanliness.
 - Ensure that the lifting equipment (where required) is in good condition.
- All personnel who are to work with these systems should be vaccinated against diseases that can occur.
 - Keep a first aid kit handy.

Health & Safety

Maintenace should be carried out by a competent contractor in accordance with the above procedures.

Health and Safety at Work legislation and good building practice.

A warning notice should be visible at the top of each access shaft - ‘danger, harmful fumes’ and ‘ respirators should be worn in this tank.’ Before entering persons must be qualified in accordance with ‘confined space’ requirements



Information contained in this data sheet is approximate and for general guidance only. In accordance with the companies policy of constant improvement and development SPEL Products reserves the right to change the specification without prior notice.

SPEL Puraceptor Class 1 **Operation and Maintenance Manual**

Service Stations

Fuel Depots

Windfarms

Switchyards

Sub Stations

Power Stations

Industrial Locations

Contents

SPEL Puraceptor - How it works	page 2
SPEL Puraceptor Maintenance	page 3
SPEL Coalescer Units	page 4
SPEL Auto Closure Device	page 5
SPEL Oil Alert System	page 6
Spare Parts List	page 8

SPEL PURACEPTOR™ CLASS 1

Oil containment

“How it works”

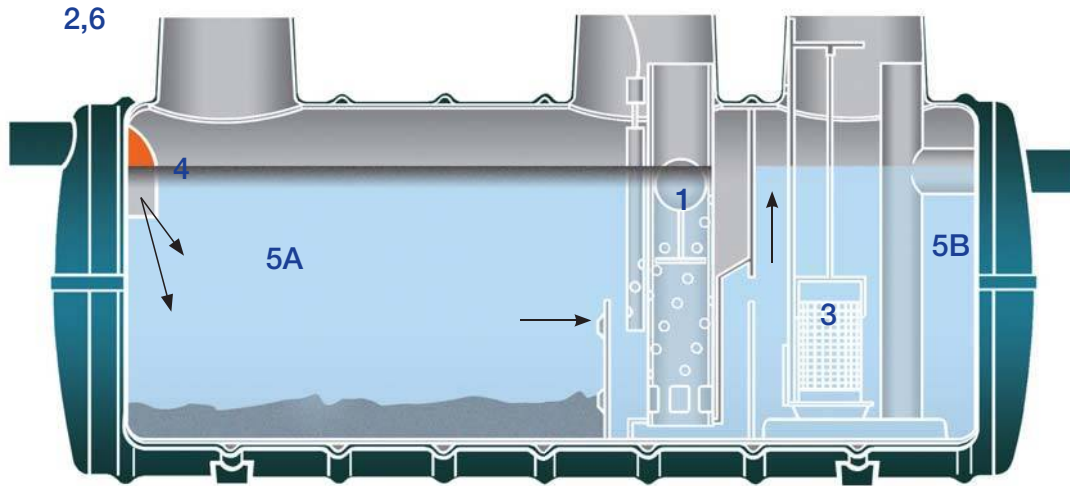

SPEL PURACEPTOR™ is a FULL RETENTION separator that treats all flows and is sized to contain more than the anticipated maximum oil spillage enabling it to be fully operational at all times.

It has two chambers, a coalescer and is fitted with an automatic closure device specifically designed to treat and contain major oil spills thereby making it suitable for high risk applications.

It achieves a water discharge quality of 5mg light liquids per litre complying to European Standard BS EN 858.1. 2006. Treatable flow rates range from 2LPS to 200LPS. Pipe sizes range from 100mm to 450mm (larger sizes on request).

Careful and proper planning by corporate Australia and government bodies is essential when designing and implementing systems that are effective in protecting our environment. The proven and independently accredited SPEL PURACEPTOR™ (complies to European Standard BS EN 858.1 2006) is an Australian made stormwater treatment and oil containment device that can contain and prevent light liquid pollutants from discharging into our waterways.

1 AUTOMATIC CLOSURE DEVICE

The AUTOMATIC CLOSURE DEVICE (A.C.D.) is a precisely engineered device comprising a water-bouyant ball that is sensitive to any change in the water density as a consequence of light liquids build up, thereby automatically activating a process of depressing the A.C.D. to SHUT OFF the separator, preventing pollutants from discharging to drains and waterways.

2 FULL RETENTION

All liquid is treated. There is no by-pass operation.

3 COALESCER EQUIPPED

Provides a coalescing process for the separation of smaller globular of light liquid pollutants to reduce the light liquid content in the outlet to **5mg/litre or less.**

4 INLET DIP PIPE - FLAME TRAP

For minimum turbulence and to prevent fire and inflammable vapours passing through to the drainage system.

5 TWO CHAMBER

A non-turbulent flow through two horizontal treatment chambers, utilising the underflow principle to retain light liquids in all flow conditions.

A. CONTAINMENT CHAMBER: Where Total Suspended Solids (TSS) silt, sediments, sludge and gross pollutants are trapped and settle on the chamber floor and where light liquids are contained.

B. COALESCER CHAMBER: Where light liquids separation is enhanced reducing it to **5mg/litre** or less prior to discharge.

6 GRAVITY OPERATED

Will function in the event of power failure and fits into existing pipe drainage systems or new sites.

7 MAINTENANCE

Easy and safe with no entering of the tank required.

SPEL SPEL PURACEPTOR™

Puraceptors™ should be inspected at three - six - or twelve monthly intervals depending on site conditions, to determine the depth of retained pollutants and silt in both chambers and the correct operating of the ACD (automatic closure device). When the depth of the oil/fuel retained has reached the predetermined design level, (approx. 50mm) or after a spill it should be cleaned out.

- 1 CONTAINMENT CHAMBER:** Where silt, sediments, sludge, gross pollutants settle out and light liquids are retained. The auto closure device operates in its retaining tube next to the oil alert sensor probe.
- 2 COALESCER CHAMBER:** Where light liquids separation is enhanced prior to discharge and where the coalescer unit is incorporated, the coalescer should be removed and cleaned in accordance with the requirements set out in the coalescer data sheet.

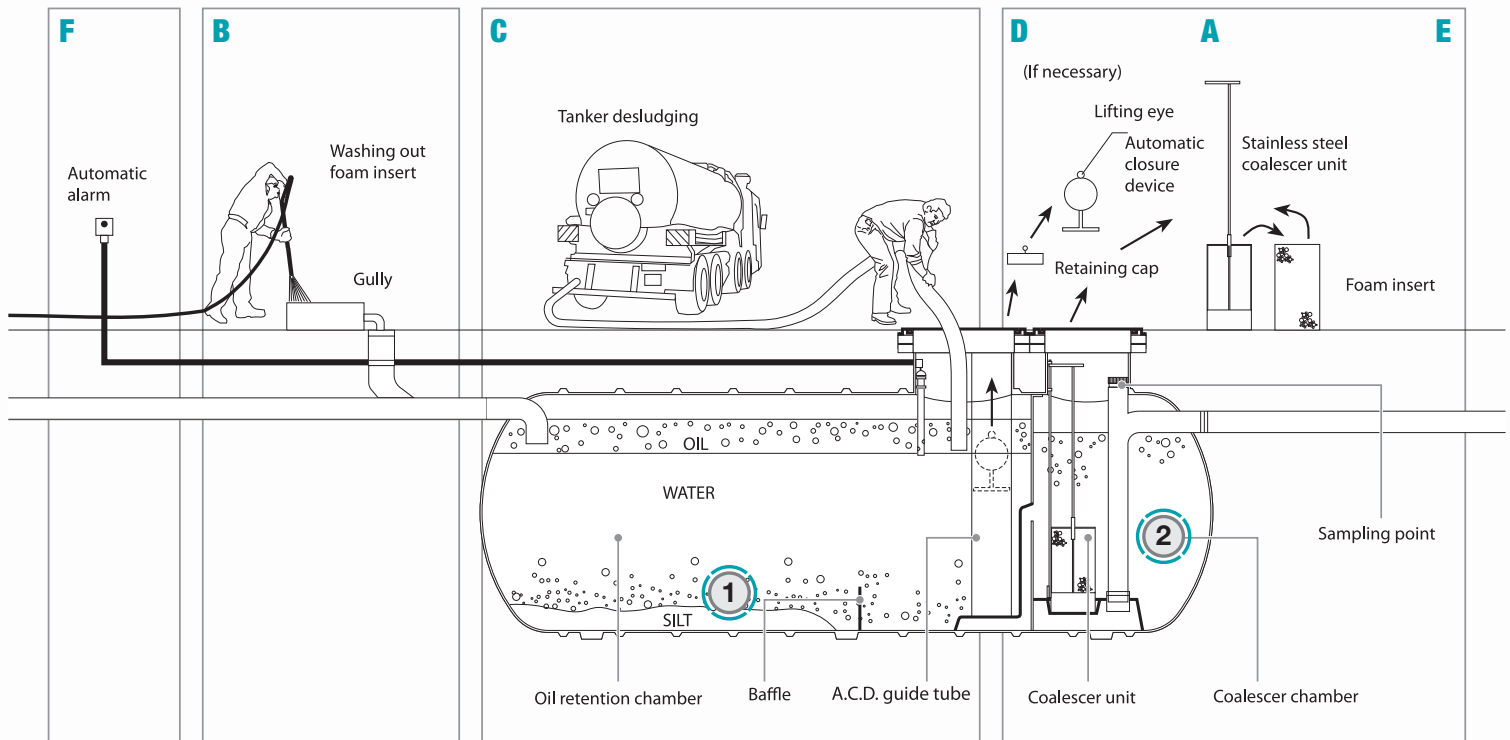

MAINTENANCE PROCEDURE

A Coalescer unit

Use the lifting handle or the chain and lift the coalescer unit out of the tank and place it near the Puraceptor™. In a retained area so pollutants do not escape.

B Cleaning foam insert

Remove foam insert and wash with normal water pressure ensuring the dirty water runs into the Puraceptor™.

C Sucking out oil/fuel and silt

Suck off the retained oil from both chambers of the Puraceptor™ and then the silt deposited on the bottom, leaving sufficient water to ensure the (auto closure device) ACD remains floating.

D Sucking out complete contents (if necessary)

If the quantity of pollutants exceeds recommended level, the complete contents of the Puraceptor™ may need to be removed. After sucking out completely, remove the ACD. Using a pole with a hook, lift out the ACD using the lifting eye on the float, if fitted.

E Re-insert coalescer unit and ACD

Re-insert the foam insert into the stainless steel coalescer unit and re-insert the coalescer unit into the Puraceptor™ as provided with the SPEL lifting/location/locking system.

Partially fill the Puraceptor™ with clean water (if necessary) to ensure the ACD when re-inserted remains floating. Re-insert the ACD.

Finally check the ACD is floating after it has been replaced to safeguard against its removal by unauthorised persons, unless depth of tank precludes doing so from ground level.

F SPEL automatic alarm/monitoring system

The SPEL automatic alarm/monitoring system probe should be lifted out of the probe protection tube, wiped clean and re-inserted. The system should now be reset according to instructions.

Important note:

When cleaning out, ensure both chambers are sucked out equally starting with the first chamber and then the second chamber and back again. Ensuring even water pressure against baffle wall.

SPEL SPEL COALESCER UNITS

The SPEL Puraceptor™ Class 1 separator and the SPEL Stormceptor™ Class 1 by-pass separators incorporate coalescer units. The coalescer units provide a coalescence process for the separation of small globules of light liquid pollutants before final discharge to the surface water drain.

Coalescers are found in the second chamber of the SPEL Puraceptor™ and the second chamber of the SPEL Stormceptor™ Class 1

Prior to installation

1. Remove any strapping / ropes which have been used to hold the coalescer units from shifting in transit.
2. The access shaft(s) above the coalescer units should be covered to prevent ingress of concrete, dust, debris etc., which could clog the foam inserts.
3. On completion of installation, check that the coalescer unit is inserted securely into the base socket.

On heavily polluted sites silt and contaminants may build up in the coalescer unit foam inserts and add significantly to its weight. Use lifting chain sets that are on hooks at ground level for safe lifting with a tripod or hoist.

Installation

During installation, it is important that the foam inserts are not clogged with dust, debris or drops of wet concrete. To safeguard against this, we recommend covering the access shaft with a sheet of polythene, if not already covered.

Commissioning

On completion of installation, check the foam insert is fitted inside the stainless steel coalescer unit and the coalescer unit is inserted securely into the base socket.

Maintenance

1. Lift handle and coalescer unit out of the tank and place in a retained area so pollutants do not escape.
2. Remove foam insert and wash with normal water pressure ensuring the dirty water runs into the Puraceptor™ / Stormceptor™.
3. Make sure the hole in the centre of the coalescer foam is facing towards the manhole when installed in the tank.
4. Re-insert the foam insert into the stainless steel coalescer unit and re-insert the coalescer into the Puraceptor™ / Stormceptor™. After the tank has been cleaned.

SPEL COALESCER UNITS GUIDE RAIL SYSTEM/LIFTING, LOCATING AND LOCKING SYSTEM

SPEL coalescer unit guide rail system

This facilitates easy insertion and removal of coalescer units. The system is robust, manufactured throughout in stainless steel and is action positive, leaving no doubt the coalescer unit is located properly.

Brackets fixed to the top and bottom of the coalescer unit simply engage the stainless steel guide rail fixed to the top of the stub access shaft. The coalescer is then lowered in the normal way, being guided at the correct angle into the conical base unit which finally locates the coalescer unit into its final position.

Extension guide rails can be incorporated into the SPEL extension shafts to suit (preferably when ordered with the separator).

However, when the separator is full of water, debris or sludge accumulated over a period could prevent the coalescer unit from re-seating correctly after servicing.

The coalescer unit lifting / locating / locking system ensures the coalescer unit is seated correctly and can be locked into position to prevent tampering.

The stainless steel lifting handle can be extended to suit deep tank inverters and provide easy access for lifting manually or with a tripod and hoist utilising the lifting hook.

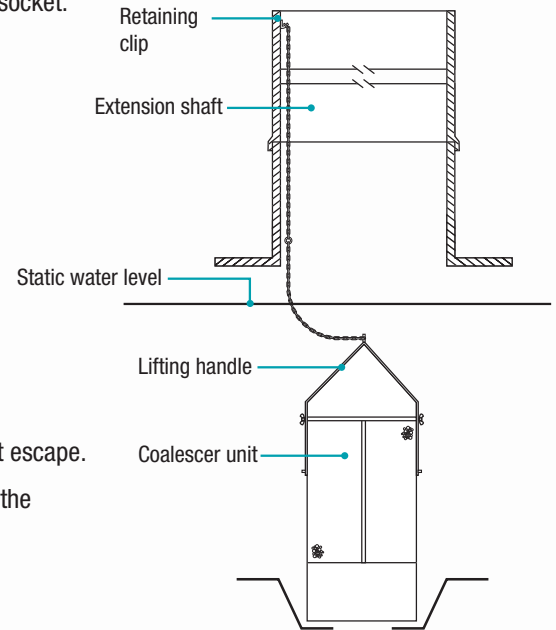

Figure 1. Coalescer unit with lifting chains

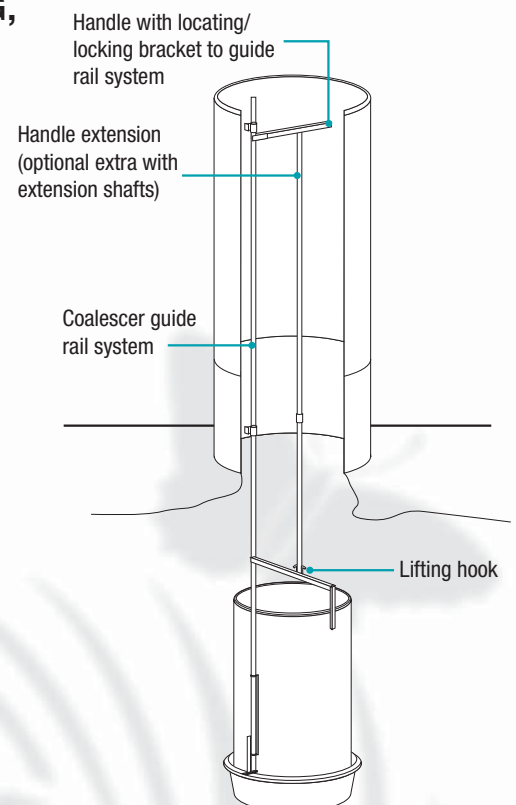

Figure 2. SPEL coalescer unit guide rail system/lifting, locating and locking system

• **SPEL ACD**The Automatic Closure Device (ACD) is found in the first chamber of a Puraceptor™. The purpose of the ACD is to close the separator off automatically when the maximum storage capacity of light liquid is attained.

The ACD is to ensure that in the event of a major spillage, pollutants do not pass into the drainage system; it should not be regarded as a substitute for an automatic alarm / monitoring system.

Prior to installation

Prior to installation the ACD retaining tube should be covered to prevent ingress of concrete etc., which could fall onto the ACD and upset it's calibration.

Operation and Maintenance

If the tank should fill with light liquid, the ACD which is calibrated for a specific gravity of 0.85, will automatically sink and close off the SPEL Puraceptor™.

Normally routine maintenance would include removing light liquid intercepted within the Puraceptor™. If a SPEL automatic alarm / monitoring system is incorporated, it will automatically indicate when the Puraceptor™ should be emptied. Only in an emergency will the Puraceptor™ fill to it's maximum and operate the ACD.

In such an event the Puraceptor™ should be completely sucked out and the ACD lifted out. Check that the ACD is in good working condition – ie. Lifting hook secure and sealed; float not leaking; knuckle joint free and clean; sealing ring intact and complete. Clean with warm soapy water before re-inserting.

To re-insert the ACD, partially fill the Puraceptor™ with clean water (if necessary) to ensure the ACD when re-inserted remains floating. Re-insert the ACD.

Finally check the ACD is floating after it has been replaced to safeguard against it's removal by unauthorised persons, unless depth of tank precludes doing so from ground level.

SPEL Puraceptor™ Class 1 separators – Two Chamber Models

Commissioning

After the tank has been installed, leave the water in.

1. Remove the ACD from the packing box, taking care not to cause damage.
2. Insert the ACD into the retaining tube using the lifting eye, if fitted, ensuring it floats correctly with the float (top section approx. 50mm) just visible above the water level.

Note: If the tank's invert depth exceeds 1 metre, it is advisable to remove the retaining cap prior to installation and only replace after inserting the ACD, if it is possible to do so from ground level.

Automatic closure device SPEL Puraceptor™ Class 1 separators (two chamber)

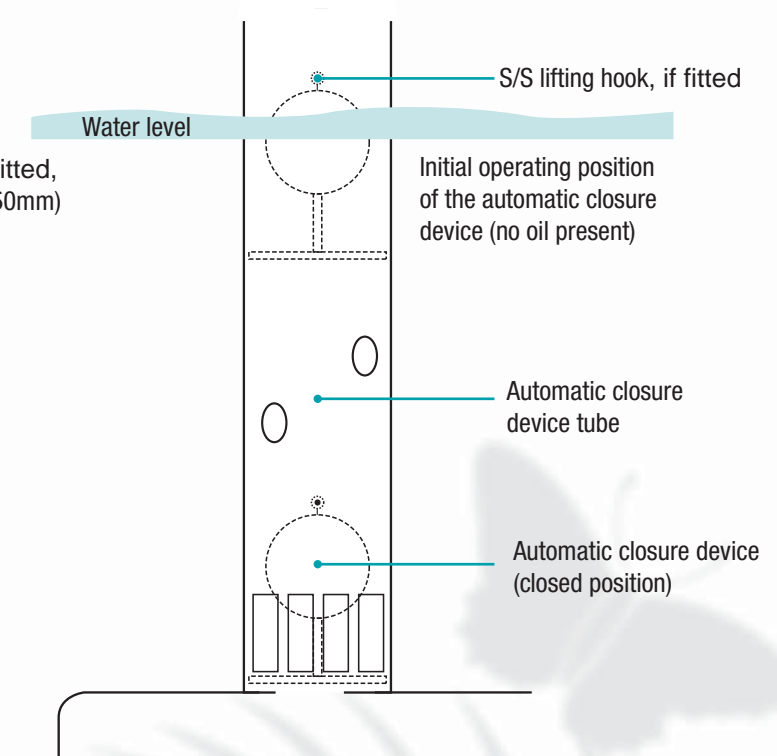

The SPEL automatic alarm/monitoring system provides a audible warning alarm when the level of the oil in the SPEL separator reaches approximately 10% of the storage volume under static liquid level conditions. This is a early warning system that is used for spills or lack of maintenance.

The system comprises of a probe mounted in the main separation chamber which senses when the designed volume of light liquids has accumulated and sends a signal to the electronic control unit activating a red 'empty now' warning light and an audible alarm,

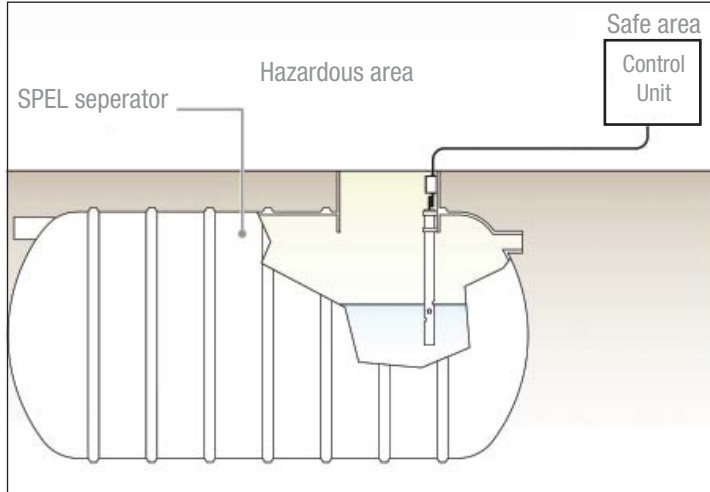

Operation

The probe is freely suspended in the probe protection tube in the separator at the correct level. When the oil-layer or depth of hydrocarbons reaches the predetermined level, the top of the probe will be immersed in the oil, breaking the circuit and activating the alarm. It is a 'fail-safe' system providing complete assurance that it is operative. If a fault occurs it will be signalled immediately.

Installation

Control unit (general positioning)

The control unit has been designed to be located indoors and outdoors, within a nonhazardous area. It should be wall mounted and positioned such that the LED display and push switches on the front panel can be readily seen and accessed. The unit can be secured to the wall by using the four mounting holes provided. Included within the control is an intrinsically safe circuit (approved according to IECEx Directive), to which the probe unit is connected.

Maintenance

When the separator is maintained, lift the probe out of the probe protection tube, check it operates the alarm (see under Tests Ref. 10.2) and at the same time wipe oil and contaminants from the probe to prevent a fake alarm after re-inserting.

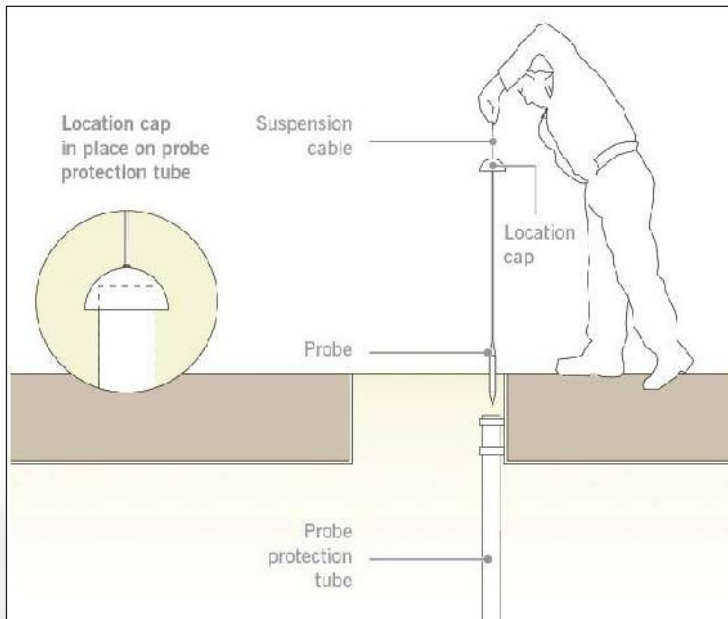
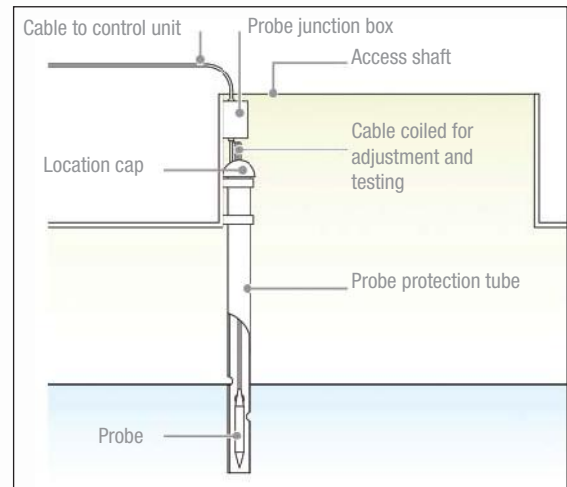

Insert probe onsite

The probe protection tube is factory fitted and the probe matched to ensure the alarm is activated when the light liquids reach approximately 10% of the storage volume the SPEL separator is designed for.

All that is required on site is to undertake the electrical installation in accordance with the instructions provided and lower the probe with the pre-fixed location cap into the probe protection tube. When the cap locates onto the top of the probe protection tube, the probe is suspended at the correct level.

Control unit (electrical connections)

1. Mains voltage connection;

The control unit should be connected to a suitable 220/240V AC supply and fused at 3 amps.

Note: This appliance must be earthed.

2. Control unit/probe junction box connection

Wiring from the control unit to the probe junction box in the separator chamber requires a 3-core screened, 0.75mm core section cable.

Maximum cable length: 300 metres.

3. Probe connection

A 5 metre 3-core probe cable is normally fitted to the junction box and the probe.

After all connections have been made, the cables must be secured by tightening each entry gland.

Probe

The probe is installed freely suspended in the SPEL separator within the probe protection tube. The 3-core cable is connected into the junction box mounted in the access shaft above the probe protection tube. Extra cable is provided to enable raising the junction box where extension shafts are incorporated.

Important note: In all cases good, standard electrical practice should be followed and the installation must conform to the Australian Wiring Rules – AS 3000 – 2007. In essence, the installation must be such that the intrinsic safety is no compromised by:

- Exposure to risk of mechanical damage
- Unauthorised modification of interference
- Exposure to moisture, dust and foreign bodies
- Excessive heat
- Invasion of intrinsically safe circuit by other electrical equipment or circuitry

Certificate of conformity

The alarm device has been approved to be used in explosion-hazardous areas. The control unit and probe are approved according to IECEx for Explosive Atmospheres. These approvals mean that the probes can be installed in Zone 0, which is continuously explosion-hazardous.

The SPEL oilset control unit must be located in the safe area, but it can be connected to the probe without any barrier.

Tests (10.2)

The function can be tested by lifting the probe within the probe protection tube. In approximately 5 seconds, the alarm is given by a red light and audible signal. Both relays release. Push the RESET button - the buzzer goes off and relay pulls in.

When the probe is placed in water again, relay pulls in and the red light goes off.

Cable break and short circuit test

Also the function can be tested in case of cable fault or short circuit. First cause short circuit in probe cable terminals 1 and 2. Then the yellow light of short circuit is lit. Both the relays pick up and the buzzer goes on. Remove the short circuit and reset the buzzer.

Simulated Function Test

The function of probe, cable and electronics can be tested. Push the TEST button for 2 to 5 seconds. Both relays pick up, and the red light is lit. When the TEST button is released, the red light goes off and relay returns to its normal position. The buzzer and relay must be reset.

Installation

Important note: It is important that installation is carried out by a competent technician familiar with this type of equipment or contact our Special Products Division for installation, commissioning and maintenance service.

SPARE PARTS LIST

DATE: _____

INVOICE NO: _____

TYPE: _____

MODEL: _____

SERIAL NO: _____

JOB NO: _____

LINE	DESCRIPTION	QTY	PART No.
1			
2			
3			
4			
5			
6			
7			
8			

For all spare parts enquiries, please ring 13 SPEL or 13 77 35

